

Documented  
second-to-none  
noise absorbing  
performance

Making the perfect match

# FiberAcoustic

Second-to-none noise absorbing performance

[www.fibertex.com](http://www.fibertex.com)

# FiberAcoustic®

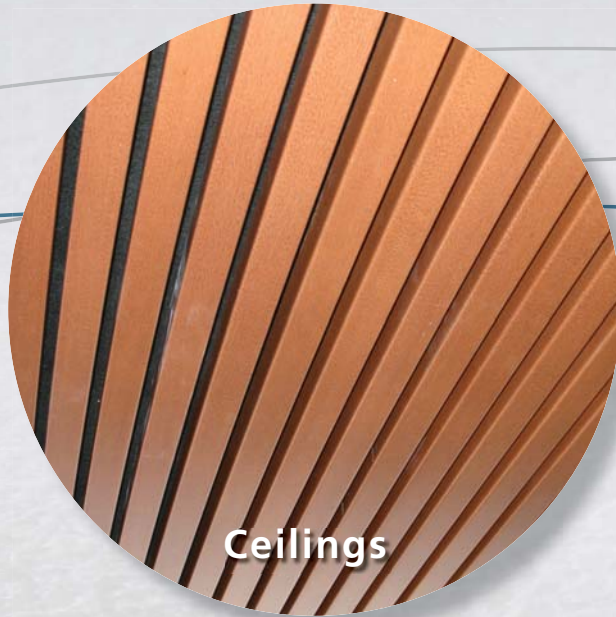

Ceilings



Wall panels

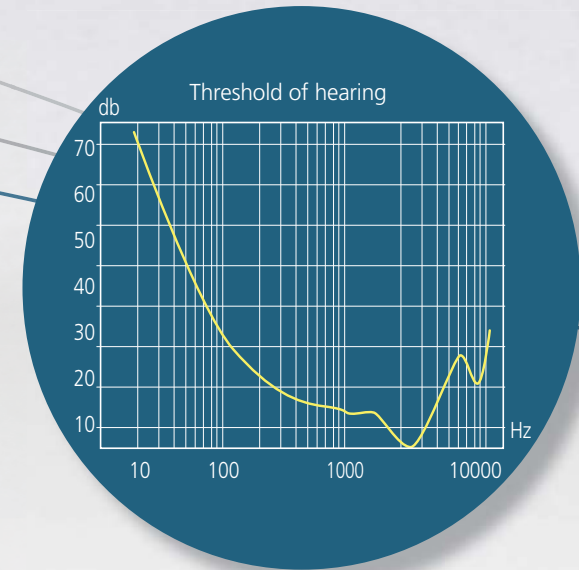

## Nonwovens properties

FiberAcoustic® nonwovens are textile-like and produced using fibres that provide significant benefits compared to competing technologies.

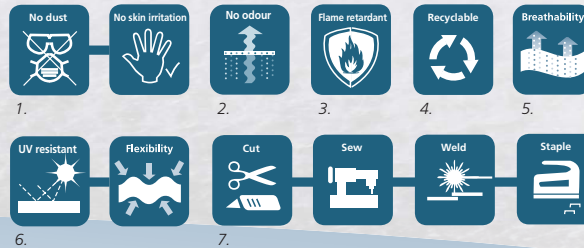

1. No loose fibres, and no face masks or gloves are required for handling.
2. Fibres are thermally bonded, preventing odour problems.
3. FR-treated fibres prevent coating 'wash-off'.
4. Materials are recyclable.
5. Fibres create a porous structure that allows breathability.
6. Fibres resist extreme environments, providing long-time durability.
7. Products are very easy to install or process using existing tools.

The unique sound absorbing properties are second-to-none and controlled extensively using equipment certified by accredited test institutes.

## FiberAcoustic®

FiberAcoustic® is a new range of acoustic performance products, each offering unique properties and sound absorbing performance for a wide range of applications. Fibertex Nonwovens has developed the product range based on extensive experience with supplying nonwovens for noise-reduction applications. We stock our products for immediate delivery, and our technical support is always available for questions.

Building on our extensive acoustics and nonwovens expertise, we continuously develop customer-specific solutions. Challenge us!

## Noise

Noise is by definition annoying. FiberAcoustic® can improve the working environment significantly due to the unique sound absorption properties.

To reduce noise exposure the noise should be shielded at the source, and reverberation time in buildings should be reduced. In working environments like offices, noise threshold limits are set to limit noise exposure. Sound absorbing materials must therefore be considered when building or renovating. When used in walls and ceiling structures, FiberAcoustic® provides unique sound absorption.

# – unique sound absorption



## Applications

FiberAcoustic® provides superior sound absorption in a wide range of applications such as wall panels, suspended ceilings and hard floor underlay. Further usage is noise barriers, automotive applications or other OEM equipment.

# FiberAcoustic® – how it works

## What is sound

Sound is changes in the air pressure, oscillating around the atmospheric pressure. For the human ear, the important parameters are the frequency and the sound level. The frequency is measured in Hertz (Hz), and describes how many times per second the sound pressure oscillates around the atmospheric pressure. At low frequencies the sound is low (bass) and at high frequencies the sound is high (treble). The sound level is measured in decibel (dB) on a logarithmic scale, and describes the deviation in air pressure from that of the ambient atmospheric pressure. Typical conversation is measured to be 60 dB, an increase to 70 dB will be perceived as a doubling of the sound intensity.

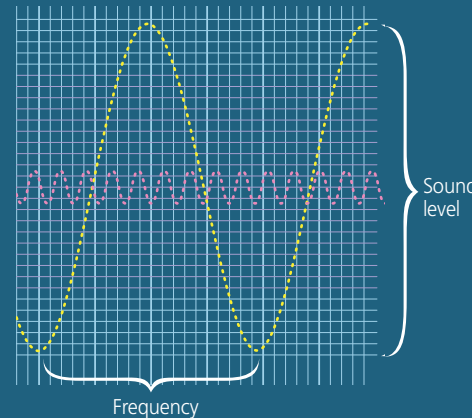

## How it works

When a sound wave strikes a surface of a material, it is either reflected or it penetrates the material. If the acoustic impedance of this material is too high, the sound waves are reflected and if the acoustic impedance is too low, the sound waves penetrate the material without being absorbed. At the proper acoustic impedance of the material, the sound energy will be absorbed and converted into heat by viscous friction between the oscillating particles of the sound medium and the structure of the porous nonwoven material. FiberAcoustic® is specially developed for optimal acoustic performance in human spaces provided by tuned acoustic impedance within a broad spectrum of frequencies.

## Sound absorption

Sound is pressure waves travelling through air. Sound absorption is the absorption of sound waves in a material and is the process where sound energy is dissipated into heat energy. The sound absorption properties of a material are characterised by the sound absorption coefficient  $\alpha$ , and vary from 0 to 1. Sound absorption of a material is frequency dependent.

$\alpha = 1.0$  equals 100% sound absorption

$\alpha = 0.0$  equals 0% sound absorption

## Why air space behind FiberAcoustic®

The space behind FiberAcoustic® is essential for the acoustic performance since it controls the frequency at which maximum sound absorption is obtained. Wide space provides absorption at low frequencies; narrow space provides absorption at high frequencies.

When a sound wave has entered the surface, the optimal acoustic impedance of FiberAcoustic® ensures that sound waves are encapsulated in the space behind FiberAcoustic®. Sound energy is removed by sound waves hitting back and forth between a solid surface and FiberAcoustic®.

The space behind FiberAcoustic® consists of either air or filling. With air as space, FiberAcoustic® ensures high acoustic performance, whereas filling moves the absorption slope towards lower frequencies.

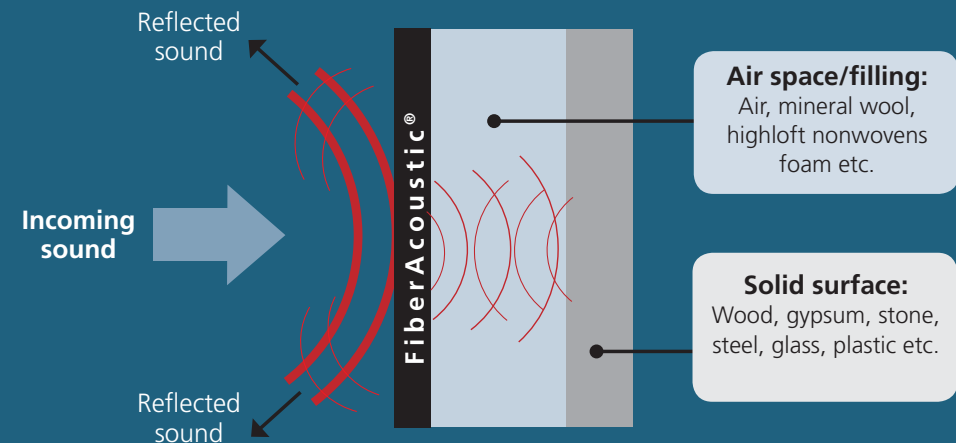

## Sound measurements

At Fibertex Nonwovens, we have the capability and facilities to perform absorption tests according to EN ISO 10534-2. This method, known as the impedance tube measurement, is suitable for the initial testing of acoustic absorption properties and controls during production, as it provides rapid results to compare product performance. Products developed for large-scale commercial production are also documented in reverberation room tests according to EN ISO 354. These tests are performed by accredited third party laboratories, and reports are available upon request.



Sound absorption coefficient –  $[\alpha]$

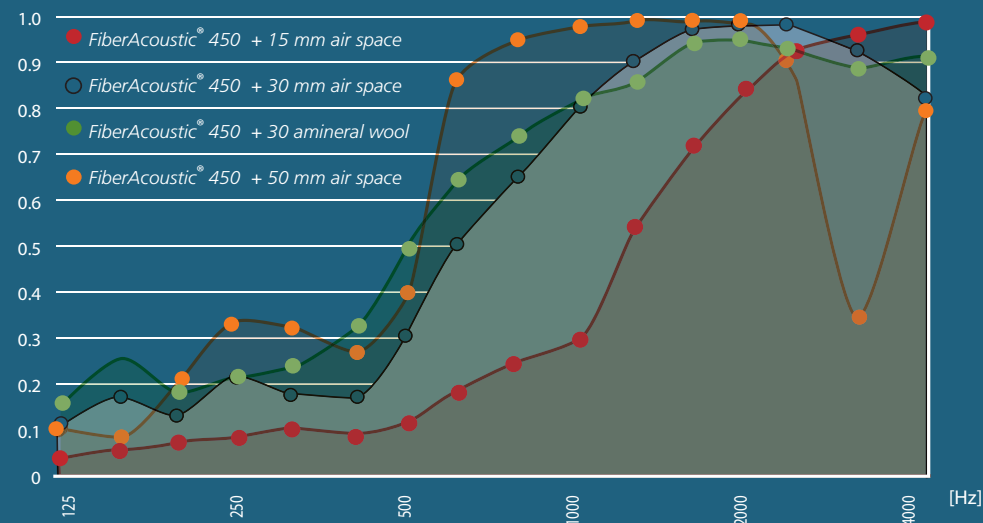

## Fire retardancy

All FiberAcoustic® products are tested and documented according to EN ISO 13501-1. All tests documenting the response to fire are performed by an external accredited test laboratory and full reports are available upon request in order to support architects, safety consultants and contractors.

The new standard EN ISO 13501-1 is considering three different aspects of response to fire: Fire resistance (B), Smoke development (s) and Burning drops (d). All FiberAcoustic® products are classified B-s1, d0 according to EN ISO 13501-1.

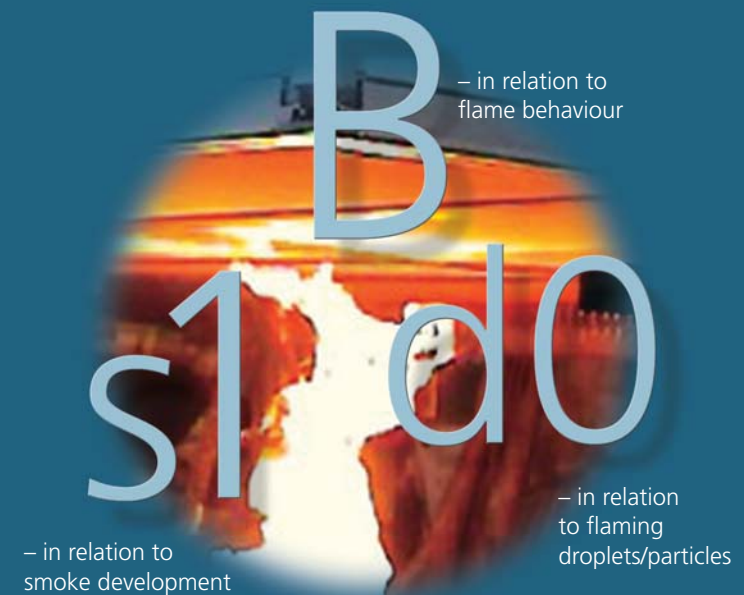

# FiberAcoustic® 75

## Technical data

06/2013

FiberAcoustic®	Standard	Unit	Value MD/CD
Weight	EN ISO 9864	g/m <sup>2</sup>	65
Tensile strength	EN 29073-3	N/5 cm	25/35
Elongation at peak	EN 29073-3	%	15/30
Thickness	EN ISO 9073-1	mm	0.3
Acoustic impedance		Ns/m <sup>3</sup>	250
Fibre blend	100% FR polyester		
Length / width	Standard 100 metres / 1200 mm		
Colour	White and black		
Flame retardancy	EN ISO 13501-1: B-s1, d0		

MD: Machine direction CD: Cross direction

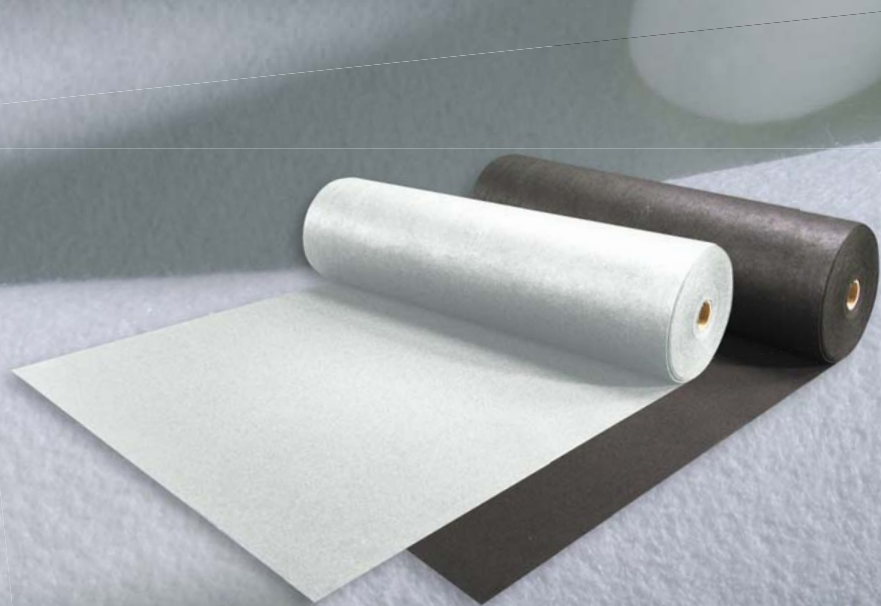

## Sound absorption coefficient

Frequency – [Hz]	100	125	160	200	250	315	400	500	630	800	1000	1250	1600	2000	2500	3150	4000	5000
Sound absorption – [α]	0.05	0.04	0.10	0.19	0.28	0.41	0.54	0.58	0.57	0.50	0.41	0.55	0.61	0.59	0.62	0.63	0.63	0.58

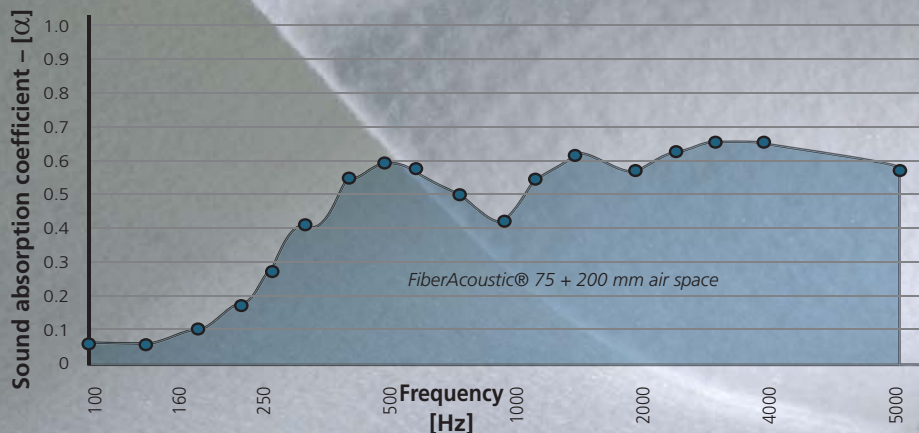

Material absorption coefficient in accordance with EN ISO 354.

## Properties

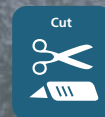

FiberAcoustic® 75

Samples  
*Samples*

# FiberAcoustic® 200

## Technical data

06/2013

FiberAcoustic®	Standard	Unit	Value MD/CD
Weight	EN ISO 9864	g/m <sup>2</sup>	200
Tensile strength	EN 29073-3	N/5 cm	325/350
Elongation at peak	EN 29073-3	%	55/90
Thickness	EN ISO 9073-1	mm	0.60
Acoustic impedance		Ns/m <sup>3</sup>	240
Fibre blend	100% polyester		
Length / width	Up to 250 metres / 2000 mm		
Colour	Black		
Flame retardancy	not for indoor use		

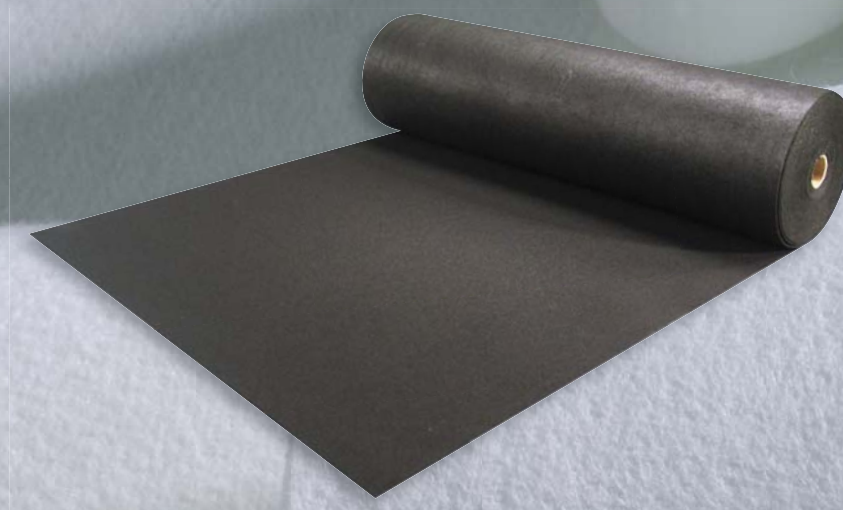

MD: Machine direction    CD: Cross direction

## Sound absorption coefficient

Frequency – [Hz]	100	125	160	200	250	315	400	500	630	800	1000	1250	1600	2000	2500	3150	4000	5000
Sound absorption – [α]	0.10	0.11	0.16	0.27	0.37	0.43	0.54	0.55	0.51	0.42	0.31	0.37	0.47	0.44	0.49	0.46	0.44	0.38

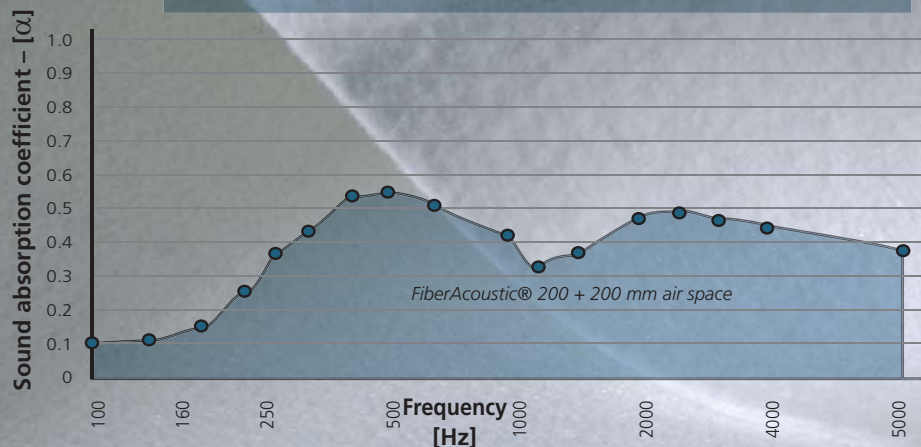

Material absorption coefficient in accordance with EN ISO 354.

## Properties

- Flexibility**
- Breathability**
- Antigraphity**
- UV resistant**
- Glue**
- Cut**
- Sew**
- Staple**



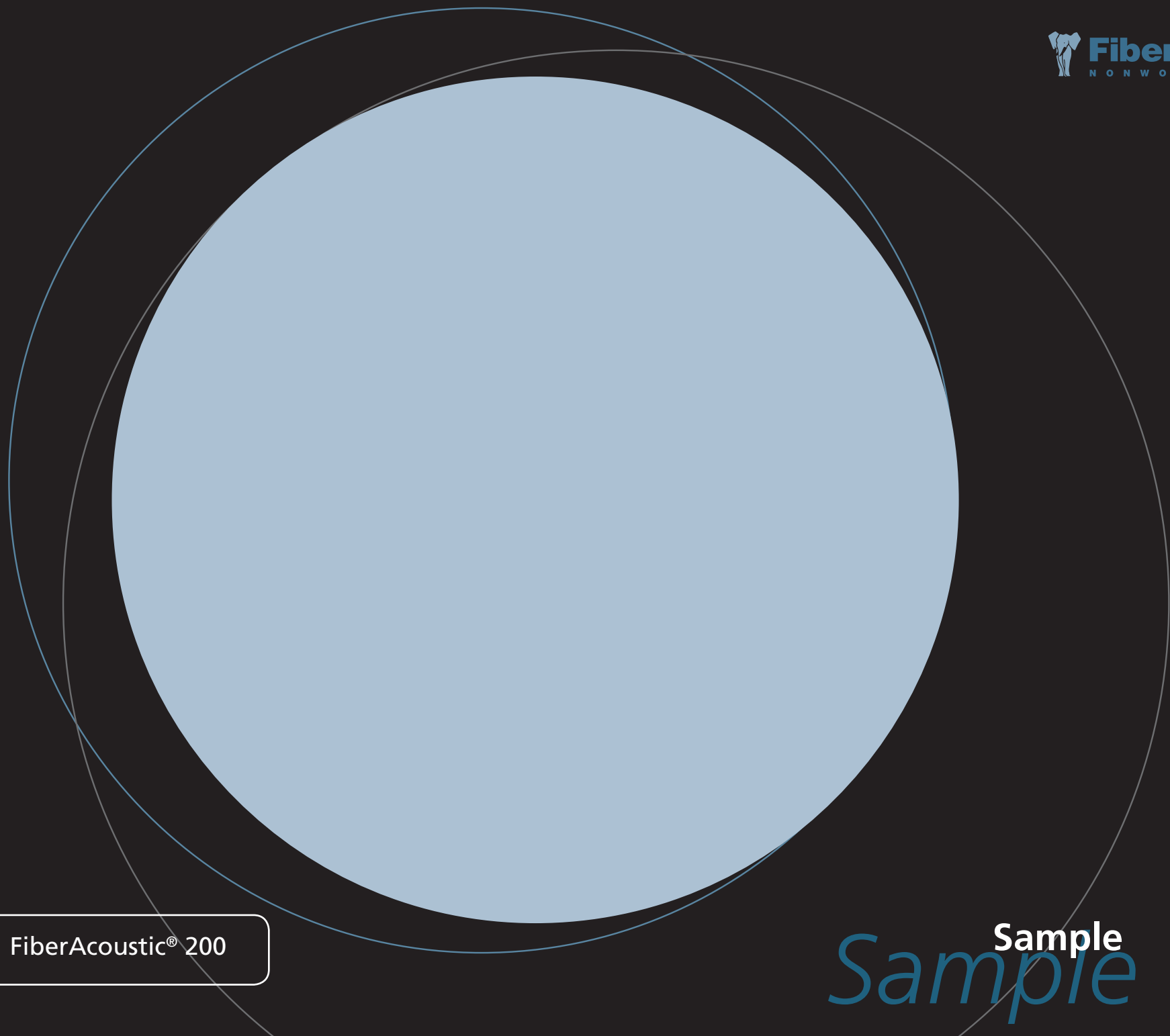

FiberAcoustic® 200

Sample  
*Sample*

# FiberAcoustic® 450

## Technical data

06/2013

FiberAcoustic®	Standard	Unit	Value MD/CD
Weight	EN 29073-2	g/m <sup>2</sup>	450
Tensile strength	EN 29073-3	N	425/800
Elongation at peak	EN 29073-3	%	80/55
Thickness	EN 29073-1	mm	2.5
Acoustic impedance		Ns/m <sup>3</sup>	600
Fibre blend	100% FR polyester		
Length / width	Standard 40 metres / 1150 mm		
Colour	White and black		
Flame retardancy	EN ISO 13501-1: B-s1, d0		

MD: Machine direction CD: Cross direction

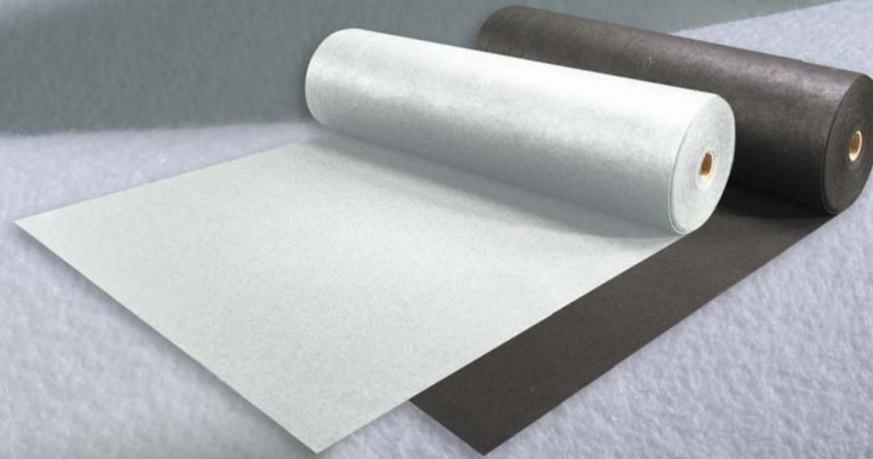

## Sound absorption coefficient

Frequency - [Hz]	100	125	169	200	250	315	400	500	630	800	1000	1250	1600	2500	3150	4000
Sound absorption - [α]	0.17	0.21	0.50	0.56	0.67	0.85	0.91	0.95	0.93	0.78	0.66	0.84	0.83	0.85	0.90	0.91

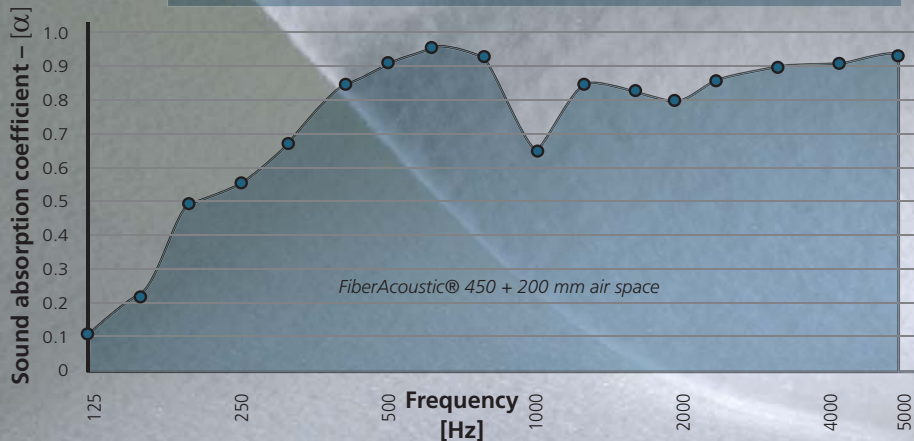

Material absorption coefficient in accordance with EN ISO 354.

## Properties



FiberAcoustic® 450

Samples  
*Samples*

# FiberAcoustic® 450 Colours

## – a new world of creative opportunities

FiberAcoustic® 450 can be supplied in any colour and offers the unique opportunity to be creative towards customer-specific designs, without compromising the acoustic performance.

- Any colour which can be specified by NCS, RAL or Pantone® codes
- The ink does not affect the product's fire properties
- Customer-specific designs e.g. logos, pictures, slogans or patterns
- Unique creative solution options
- We encourage you to challenge us to provide state-of-the-art quality, performance and visual appearance

### **NCS, RAL or Pantone®.**

There are different colour classification systems. Whether the colours you need are specified by NCS, RAL or Pantone® colour codes, we can make it. The code ensures that a chosen colour can be reproduced. This is especially important where a printed object or text is used to create an association with a specific company or product.



FiberAcoustic® 450

Material absorption coefficient in accordance with EN ISO 9914-2  
FiberAcoustic® 450 with 27.5 mm aperture

Samples  
*Samples*

# FiberAcoustic® – integrated in the applications

## Suspended ceilings

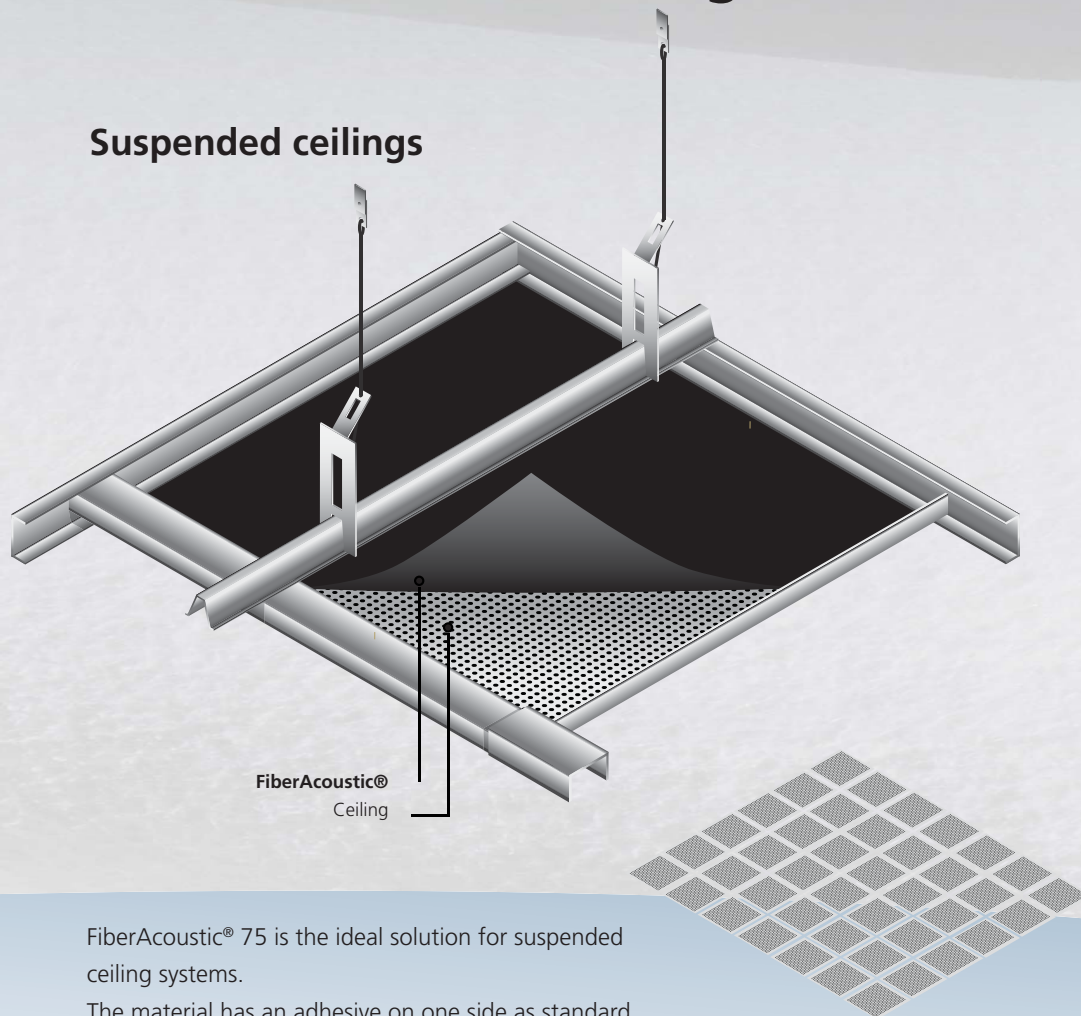

FiberAcoustic® 75 is the ideal solution for suspended ceiling systems.

The material has an adhesive on one side as standard, and is compatible with most heat press processes.

The adhesive performs well with most common base materials such as steel and wood.

FiberAcoustic® is easy to cut to the right size and shape, yet it is tough and strong, making it easy to work with at the construction site or in the heat press facility.

## Wall panels

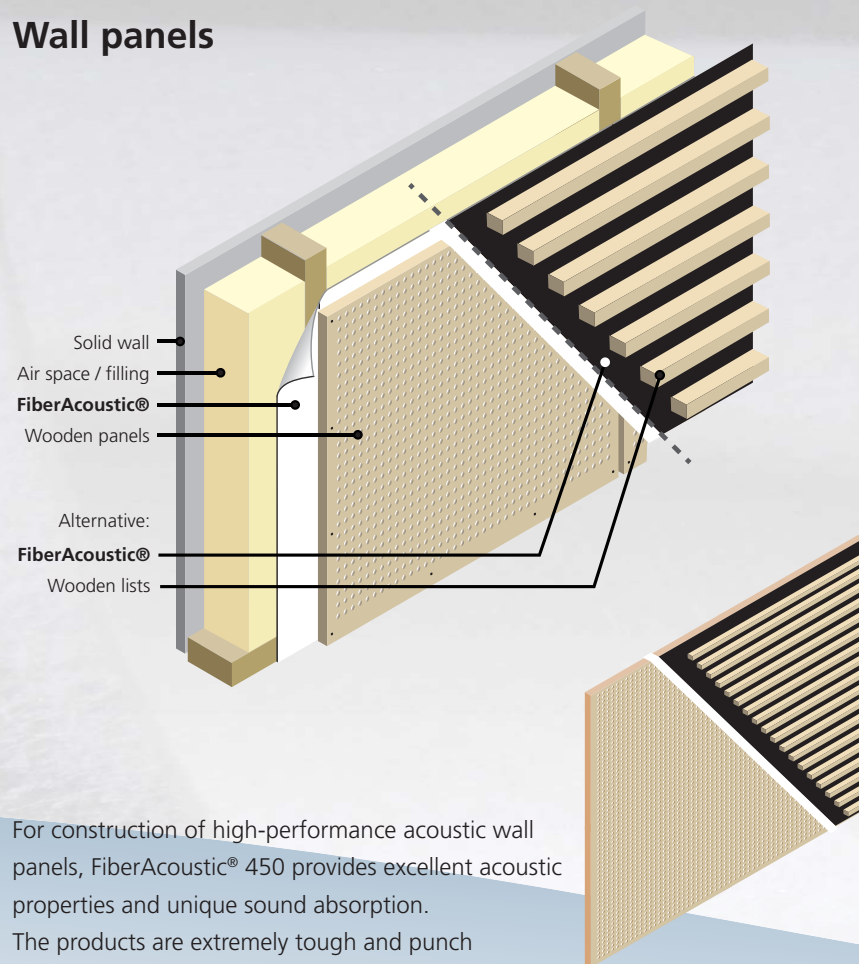

For construction of high-performance acoustic wall panels, FiberAcoustic® 450 provides excellent acoustic properties and unique sound absorption.

The products are extremely tough and punch resistant and will withstand most impacts without being damaged and without losing performance. FiberAcoustic® 450 is very flexible and can easily be bent and shaped to fit corners and odd angles.

## Screens

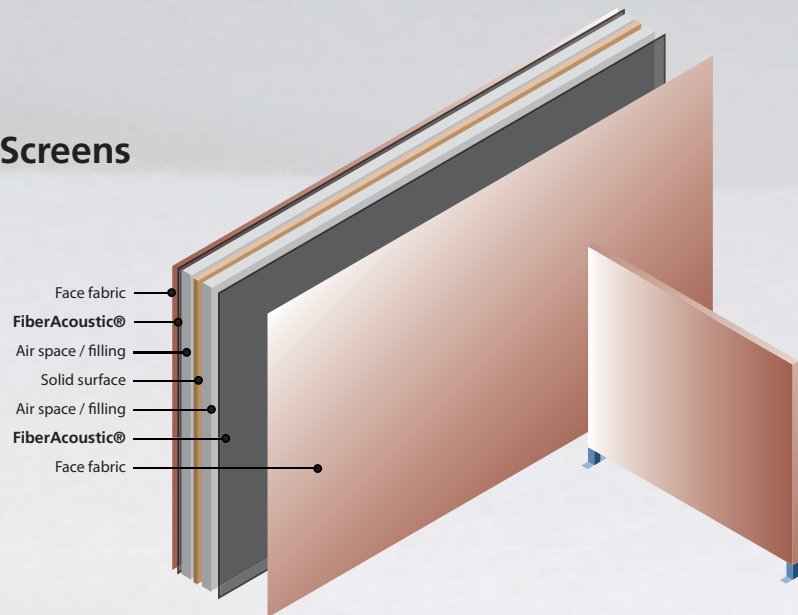

For screens, FiberAcoustic® provides superior noise absorbance while ensuring a high degree of flexibility in terms of choosing the right fabrics. As the acoustic performance is already ensured, the face fabric can be chosen with focus on design and colour.

## Baffles

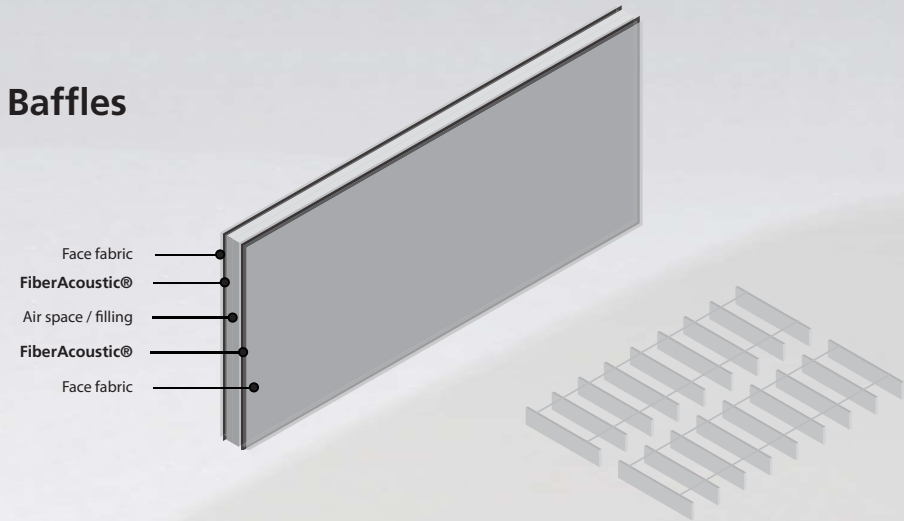

For constructors and designers of acoustic baffles, FiberAcoustic® provides a unique opportunity to work with e.g. customer-specific colours, logos or message prints without compromising excellent acoustic performance.

## Curtains

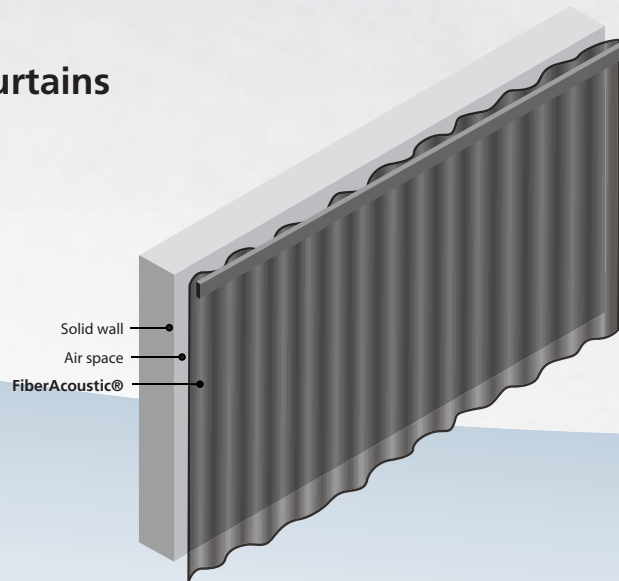

## Highway screens

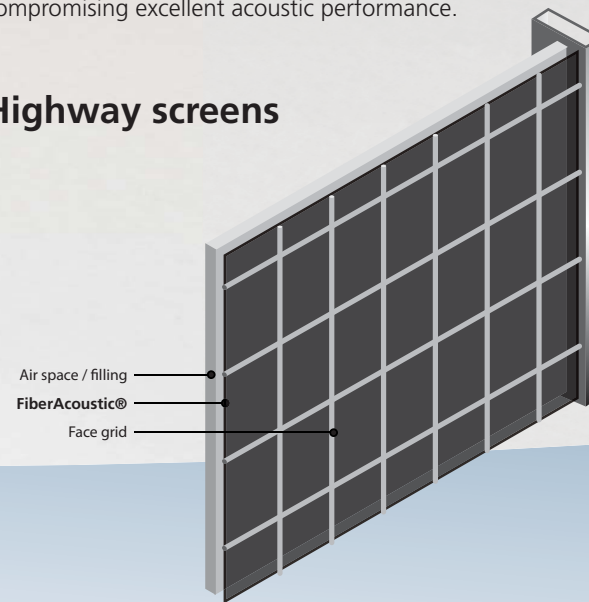

# Installation and maintenance of wall panels

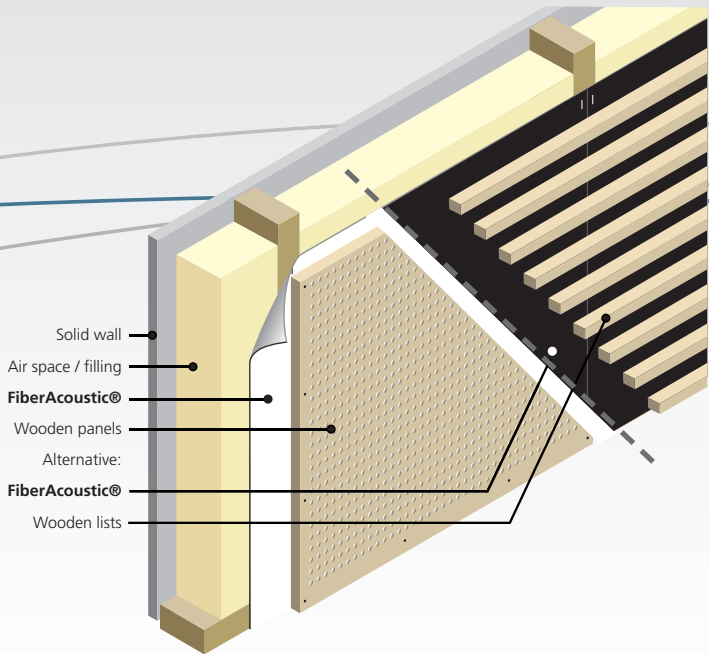

For use in wall panels FiberAcoustic® offers great installation flexibility. By nature, FiberAcoustic® is flexible and can be fitted and mounted in many ways and on all constructions.



FiberAcoustic® is resistant to all common cleaning detergents, and can be vacuum cleaned and/or wiped using a damp cloth.

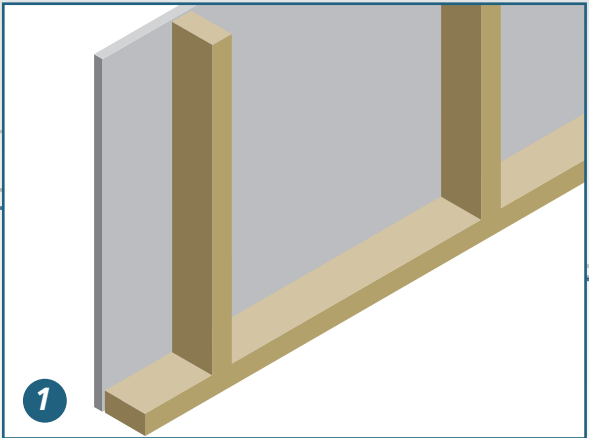

Built up of wooden or steel structure.

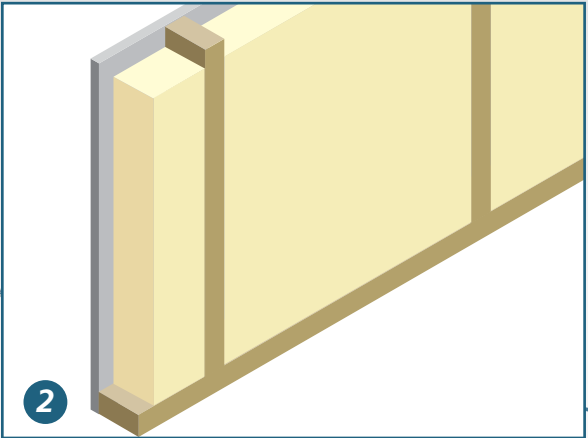

Mineral wool to be installed. It is important that the mineral wool is minimum as thick as the wood/steel laths.

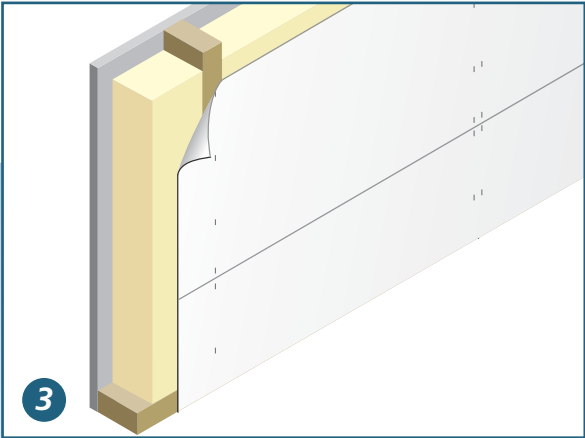

FiberAcoustic® is fastened by clamps, nails, screws or glue.

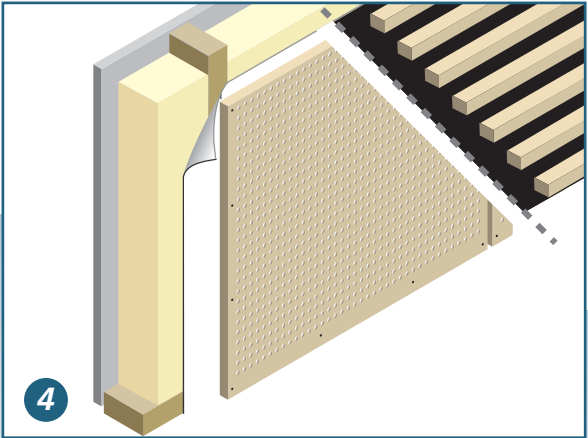

Panels or lists are installed.



# Applications

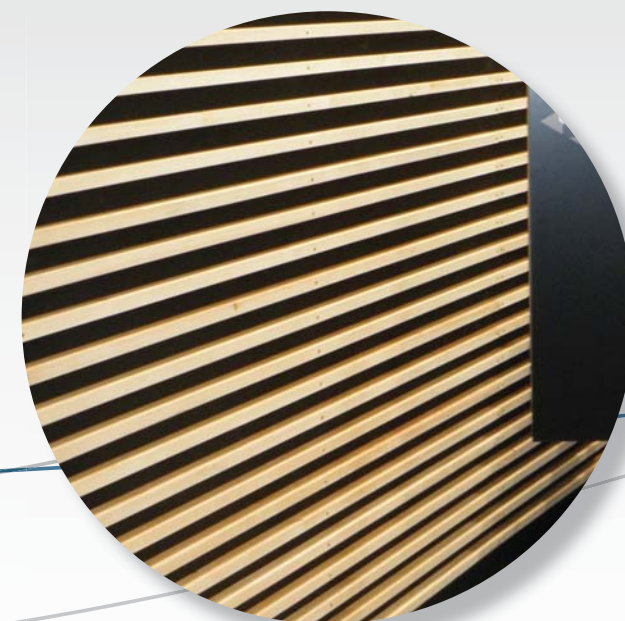

# Other applications



## Automotive

Within the automotive industry sound absorbing materials are essential to obtain premium comfort. Fibertex Nonwovens is the leading European manufacturer of materials used in sound absorbing applications in cars. Typical product end uses:

- Lightweight products. Used in car roofs to reduce high-frequency noise.
- Heavyweight, needled PET fabric. Used in moulded wheel arches to reduce tire noise.
- Facing fabrics for bonnet insulation to reduce engine noise.
- Cotton composites for use in carpet moulding to reduce noise from car bottom.



## Flooring

In hard floor applications, Fibertex Nonwovens has for many years supplied needlepunched nonwoven materials that provide foot step dampening. Products are used with or without moisture barrier foil and overlapping seams. The products are user-friendly and durable and compensate for minor unevennesses in the subfloor construction. The efficiency is well documented through test.

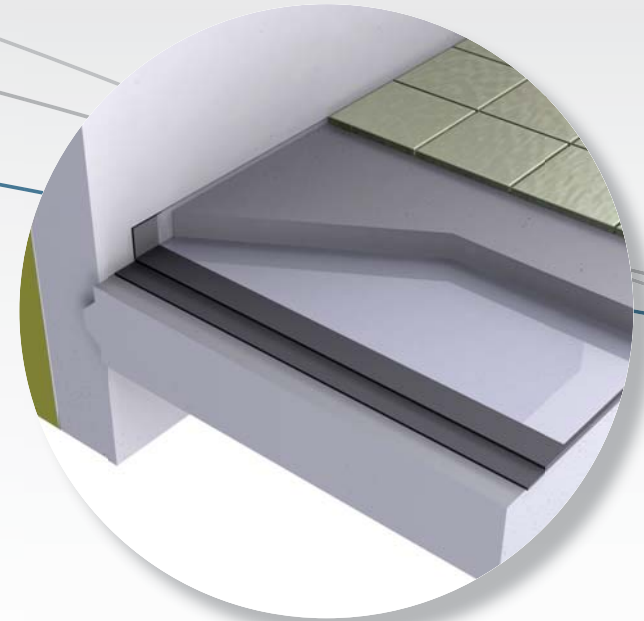

## Construction

In the constructions of buildings where concrete slabs are used to separate the individual stories, two layers of Fibertex nonwovens are used in between the slab and the cast concrete flooring to reduce noise transported through the construction.

The variety of FiberAcoustic® products offers unique opportunities for creative and performance-focused architects and constructors within a wide range of business areas. FiberAcoustic® will give you the solutions you need to meet your clients' requirements.

Whatever your sound absorption requirements – challenge us!



### **Furniture**

Fibertex Nonwovens can offer you professional advice on how to incorporate acoustic materials in your furniture, which will differentiate and add value to your business. Typical applications include office screen walls, sound absorbing surfaces on the back of bookcases and surfaces underneath desks and sofas. Materials can also be used for decorative wall coverings, offset inkjet printing or unique paintings.

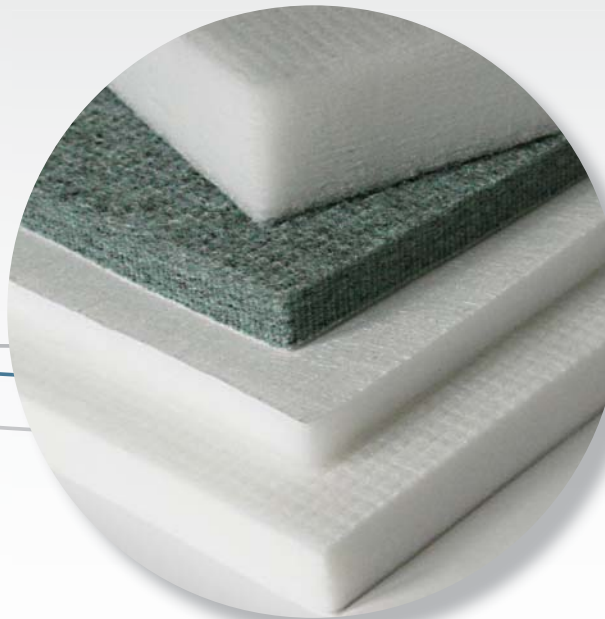

### **Porous absorbers**

To reduce weight or minimise the environmental impact, traditional foam absorbers can be substituted with high loft nonwoven materials based on virgin fibre material or reused material. This is typically used in household appliances or industrial applications where the weight-performance ratio is of major importance. High loft fibre absorbers can also be equipped with self-adhesive glue to ease installation.

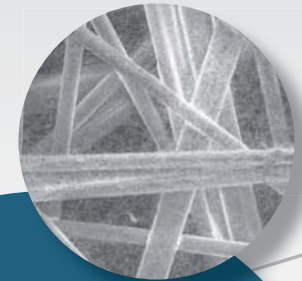

## **Challenge us!**

Fibertex Nonwovens is continuously developing new customer-specific applications.

In future, even more options will be available using new nanofibre technology.



# Business areas



Acoustics



Automotive



Bedding



Building industry



Composites



Concrete



Flooring



Filtration

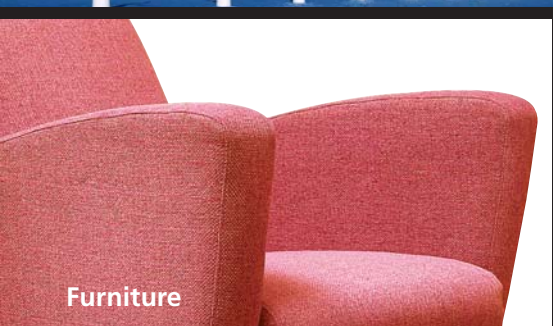

Furniture



Geotextiles



Horticulture



Home & Garden

## Facts about Fibertex

Fibertex Nonwovens is a market-leading manufacturer of nonwovens for industrial and technical applications.

With corporate office in Aalborg, Denmark, and manufacturing sites in Denmark, the Czech Republic, France and South Africa, Fibertex is globally represented. Since its foundation in 1968, Fibertex has expanded continuously and today manufactures nonwovens for customers all over the world for many different applications.



Fibertex Nonwovens A/S is certified according to DS/EN ISO 9001 and 14001. Q-Match® - digitally integrated quality management system - provides instant electronic control of product quality and process capability.



**Fibertex Nonwovens A/S**

Svendborgvej 16  
DK-9220 Aalborg  
Denmark  
Tel. +45 96 35 35 35  
Fax +45 98 15 85 55  
fibertex@fibertex.com

**Fibertex Nonwovens, a.s.**

Prumyslova 2179/20  
CZ-568 23 Svitavy  
Czech Republic  
Tel. +420 461 573 211  
Fax +420 461 541 437  
info@fibertex.com

**Fibertex Nonwovens S.A.**

3-5 rue de la Croix Renaudeau  
Z.I. de la Pierre Blanche  
B.P. 49 - 49120 Chemillé - France  
Tél. + 33 (0)2 41 71 55 55  
Fax + 33 (0)2 41 71 55 78  
saleschemille@fibertex.com

**Fibertex South Africa (Pty) Ltd.**

16 Van Eck Avenue  
Hammarisdale 3700  
ZA-KwaZulu Natal – South Africa  
Tel. +27 (0)31 700 6657  
Fax +27 (0)31 700 6659  
salesza@fibertex.com

**[www.fibertex.com](http://www.fibertex.com)**